

Microwave Frequency Synthesizer

Available 6-20 GHz (In bands)

Example 8.0-9.0 GHz

Features

Low phase noise
Low sensitivity to shock and vibration
Low power consumption
Small size
Custom designs available

Applications

Digital microwave radio
Satcom converters
Test equipment
Radar

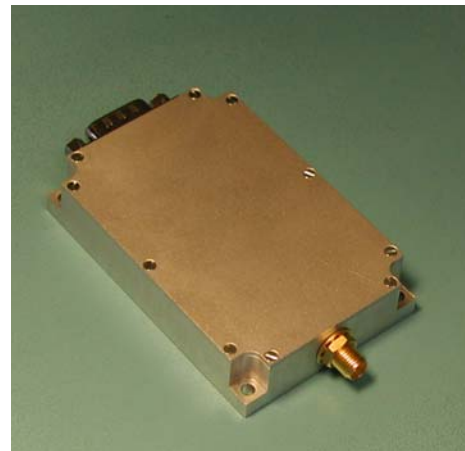

TYPICAL PERFORMANCE SPECIFICATIONS

Output frequency:	8.0-9.0 GHz
Step size:	20 MHz
Settling time:	< 1 ms for 100 MHz frequency step
Output power:	+8 dBm
Output power variation:	+/- 1.5 dBm
Typical Phase noise:	-80 dBc/Hz@10 KHz, -100 dBc/Hz@100 KHz
Spurious output:	< -65 dBc
Harmonics:	< -30 dBc
Sub harmonics	< -50 dBc
Reference frequency:	External Reference: 5 – 100 MHz Option: Internal Reference
Frequency accuracy:	Same as reference. (Internal Reference: +/- 10 ppm)
Frequency control:	3-wire serial interface.
DC power consumption:	< 2.5 W
Operating temperature:	-35 °C to + 80 °C
Size:	75 x 50 x 15 mm

Date Dec 18 , 2006

Microwave Frequency Synthesizer

Available 6-20 GHz (In bands)

Example 8.0-9.0 GHz

Outline drawing:

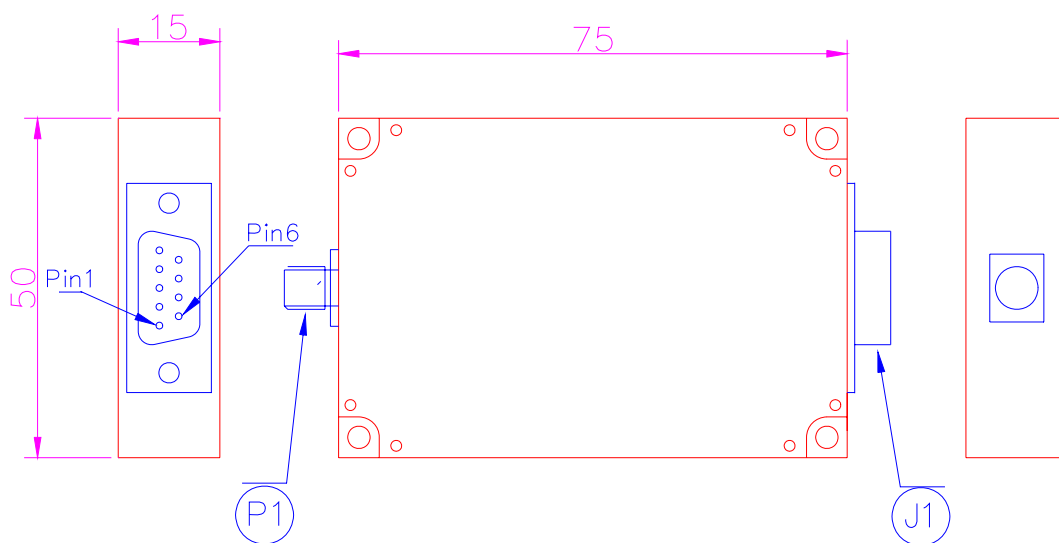

Connectors marking:

P1: RF Output

J1: DC Supply, Freq. control and alarm

SMA-F

D-Sub 9 pin Male

J1 Connector :

J1 Pinout table:

Pin 1:	Enable
Pin 2:	Data
Pin 3:	Clock
Pin 4:	Lock Detect
Pin 5:	Test
Pin 6:	- 12V
Pin 7:	+12V
Pin 8:	+ 5V
Pin 9:	GND

Date Dec 18 , 2006